

SKET 400



SEMIPACK[®] 4

Thyristor Modules

SKET 400

Features

- Heat transfer through aluminium nitride ceramic isolated metal baseplate
- Precious metal pressure contacts for high reliability
- Thyristor with amplifying gate
- UL recognized, file no. E 63 532

Typical Applications

- DC motor control (e. g. for machine tools)
- Temperature control (e. g. for ovens, chemical processes)
- Professional light dimming (studios, theaters)

- 1) See the assembly instructions
- 2) The screws must be lubricated

V_{RSM} V	V_{RRM}, V_{DRM} V	$I_{TRMS} = 700$ A (maximum value for continuous operation) $I_{TAV} = 400$ A (sin. 180; $T_c = 84$ °C)	
900	800	SKET 400/08E	
1300	1200	SKET 400/12E	
1500	1400	SKET 400/14E	
1700	1600	SKET 400/16E	
1900	1800	SKET 400/18E	

Symbol	Conditions	Values	Units
I_{TAV}	sin. 180; $T_c = 85$ (100) °C;	392 (280)	A
I_D	P16/300F; $T_a = 35$ °C; B2 / B6	700 / 880	A
I_{RMS}	P16/400F; $T_a = 35$ °C; W1 / W3	905 / 3 * 720	A
I_{TSM}	$T_{vj} = 25$ °C; 10 ms	14000	A
	$T_{vj} = 130$ °C; 10 ms	12000	A
i^2t	$T_{vj} = 25$ °C; 8,3 ... 10 ms	980000	A ² s
	$T_{vj} = 130$ °C; 8,3 ... 10 ms	720000	A ² s
V_T	$T_{vj} = 25$ °C; $I_T = 2400$ A	max. 1,7	V
$V_{T(TO)}$	$T_{vj} = 130$ °C	max. 0,92	V
r_T	$T_{vj} = 130$ °C	max. 0,3	mΩ
I_{DD}, I_{RD}	$T_{vj} = 130$ °C; $V_{RD} = V_{RRM}, V_{DD} = V_{DRM}$	max. 130	mA
t_{gd}	$T_{vj} = 25$ °C; $I_G = 1$ A; $di_G/dt = 1$ A/μs	1	μs
t_{gr}	$V_D = 0,67 * V_{DRM}$	2	μs
$(di/dt)_{cr}$	$T_{vj} = 130$ °C	max. 125	A/μs
$(dv/dt)_{cr}$	$T_{vj} = 130$ °C	max. 1000	V/μs
t_q	$T_{vj} = 130$ °C	150 ... 200	μs
I_H	$T_{vj} = 25$ °C; typ. / max.	150 / 500	mA
I_L	$T_{vj} = 25$ °C; $R_G = 33$ Ω; typ. / max.	500 / 2000	mA
V_{GT}	$T_{vj} = 25$ °C; d.c.	min. 3	V
I_{GT}	$T_{vj} = 25$ °C; d.c.	min. 200	mA
V_{GD}	$T_{vj} = 130$ °C; d.c.	max. 0,25	V
I_{GD}	$T_{vj} = 130$ °C; d.c.	max. 10	mA
$R_{th(j-c)}$	cont.	0,09	K/W
	sin. 180	0,095	K/W
	rec. 120	0,11	K/W
$R_{th(c-s)}$		0,02	K/W
T_{vj}		- 40 ... + 130	°C
T_{stg}		- 40 ... + 130	°C
V_{isol}	a. c. 50 Hz; r.m.s.; 1s / 1 min.	3600 / 3000	V~
M_s	to heatsink	5 ± 15 % ¹⁾	Nm
M_t	to terminal	17 ± 15 % ²⁾	Nm
a		5 * 9,81	m/s ²
m	approx.	940	g
Case		A 36	

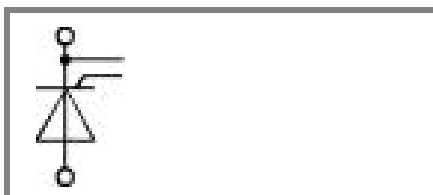

SKET

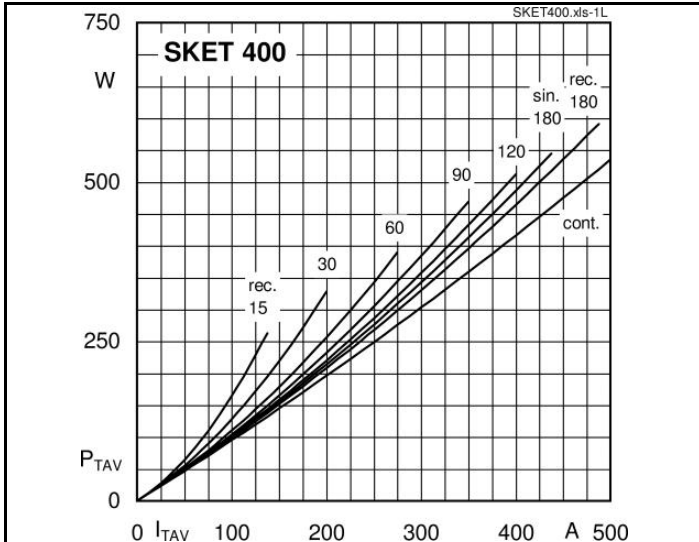

Fig. 1L Power dissipation per thyristor vs. on-state current

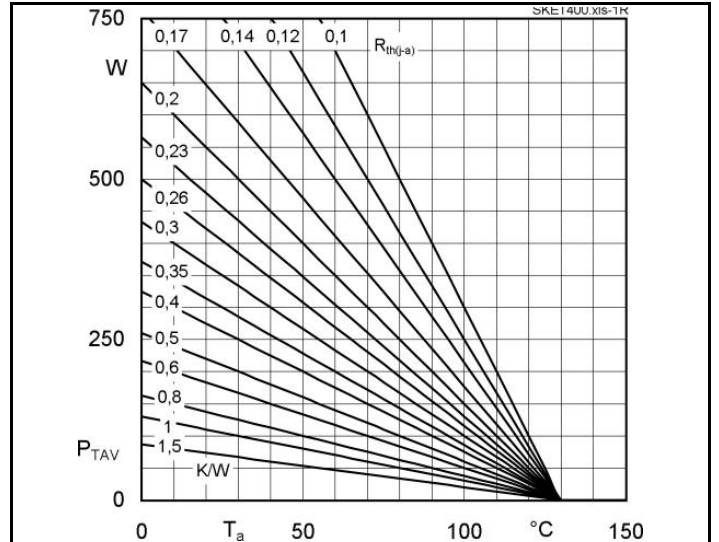

Fig. 1R Power dissipation per thyristor vs. ambient temp.

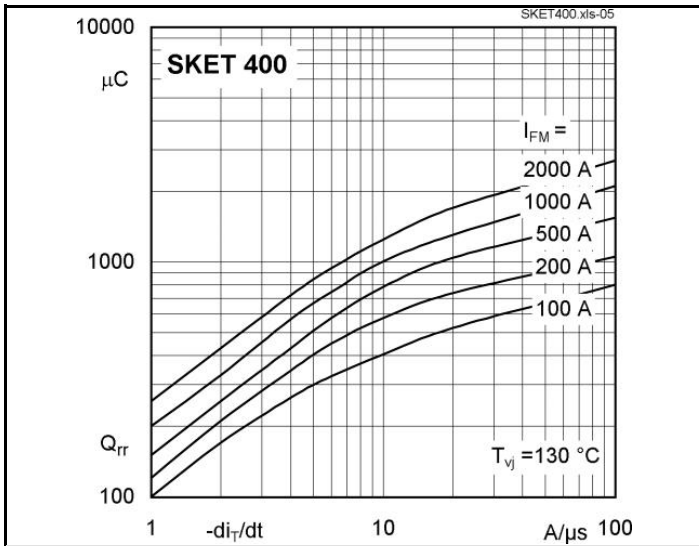

Fig. 5 Recovered charge vs. current decrease

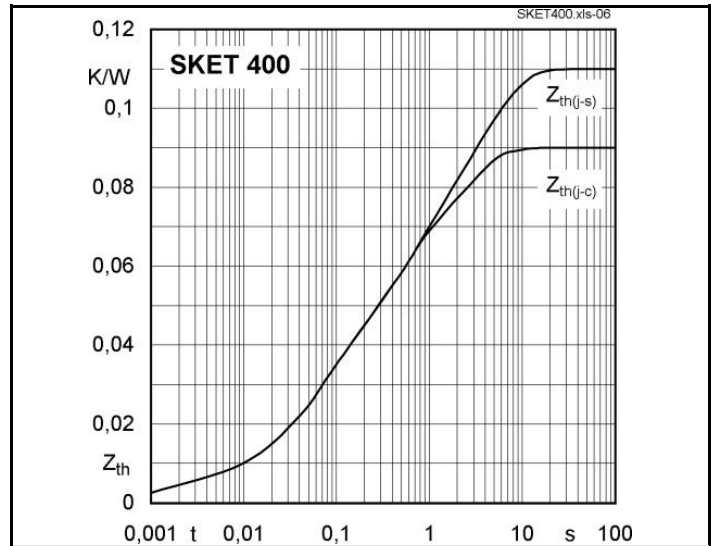

Fig. 6 Transient thermal impedance vs. time

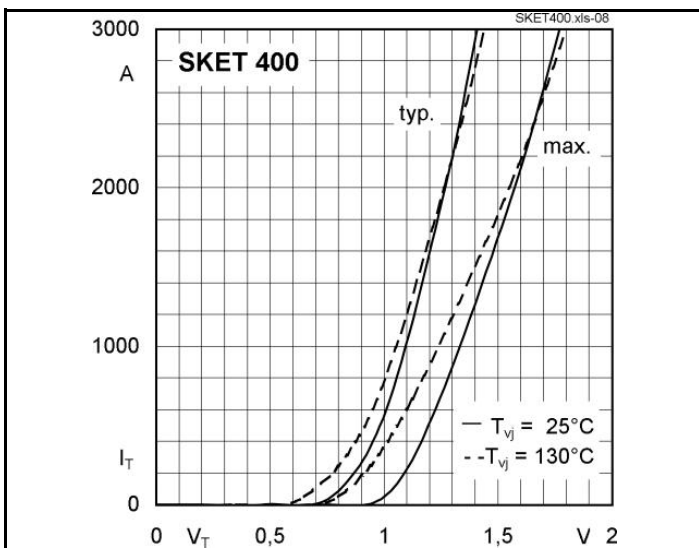

Fig. 7 On-state characteristics

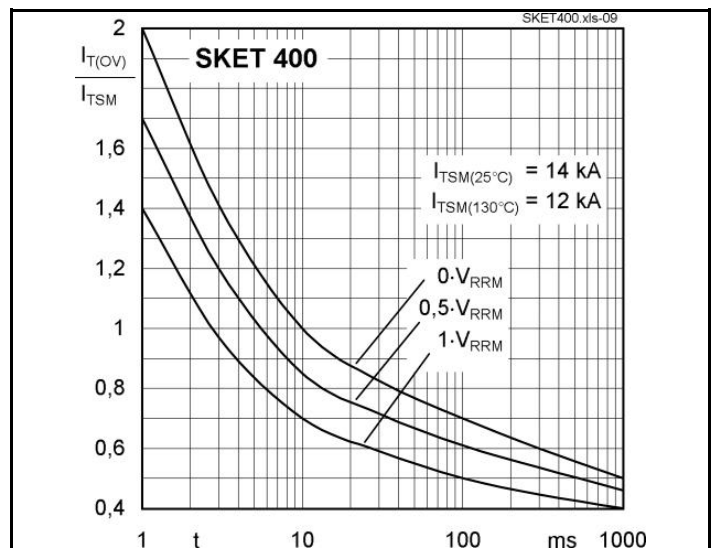
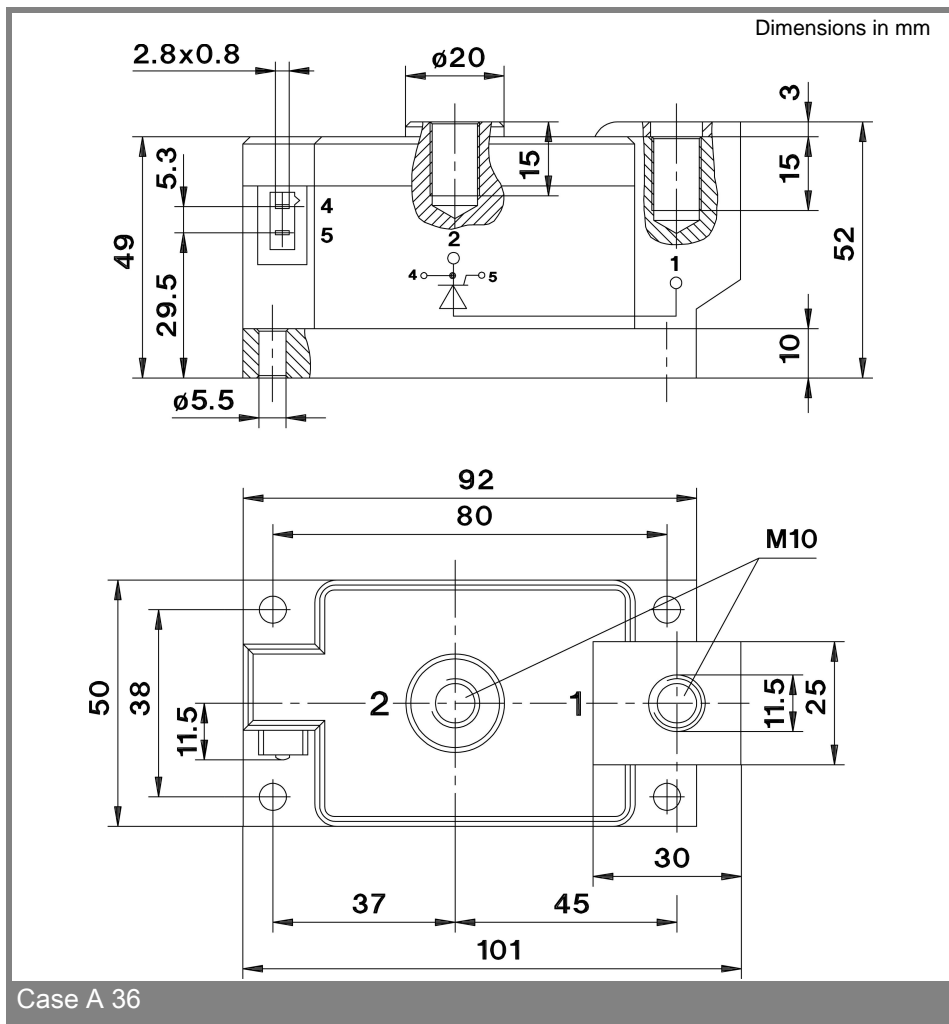
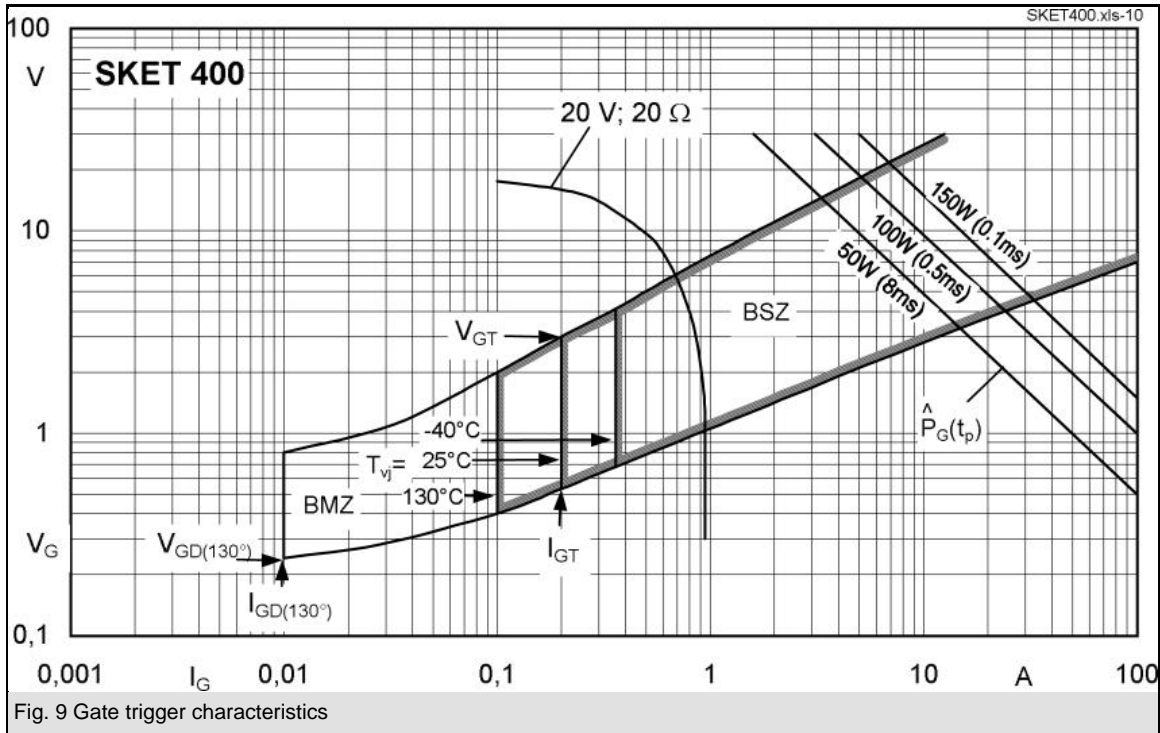

Fig. 8 Surge overload current vs. time

SKET 400



This technical information specifies semiconductor devices but promises no characteristics. No warranty or guarantee expressed or implied is made regarding delivery, performance or suitability.